











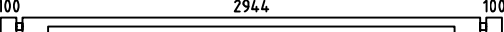
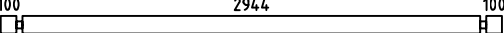
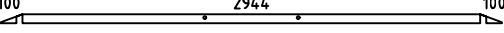
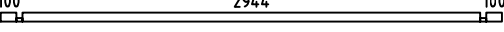
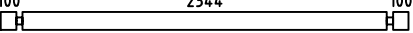
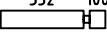
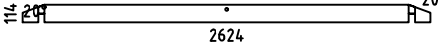
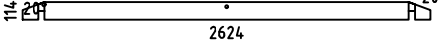
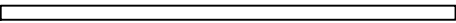
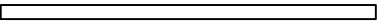
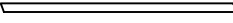
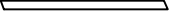



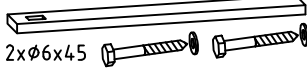
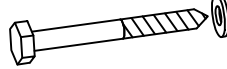

Cornelia40



Pos	Specification-Spezifikation-Specificatie Cornelia40 ISO	St.	Profile (mm)	Length (mm)
001		2	40x57	305
002		32	40x114	305
003		1	40x114	3224
004		19	40x114	3224
005		2	40x57	3224
006		1	40x57	3224
007		12	40x114	2624
008		48	40x114	672
WA-1		1		
WB-1		1		
F2	FOUNDATION-GOLVBJÄLKE-FUNDAMENT-FONDATION 	8	44x90	2926
F1	FOUNDATION-GOLVBJÄLKE-FUNDAMENT-FONDATION 	2	44x90	2414
RT1	RAFTER-TAKBALK-SPARRE-CHEVRON 	4	45x55	1673
RT2	RAFTER-TAKBALK-SPARRE-CHEVRON 	6	45x55	1225
RT3	RAFTER-TAKBALK-SPARRE-CHEVRON 	1	45x55	644
F-1	FLOOR BOARD-GOLVBRÄDA-FUSSBODENBRETT-LAME DE PLANCHER 	34+1	88x18	2334
GB-1	GABLE BOARD 95-GAVELBRÄDA-GIEBELBLENDE-PLANCHE DE RIVE 	2	18x95	2874
GB-2	GABLE BOARD 95-GAVELBRÄDA-GIEBELBLENDE-PLANCHE DE RIVE 	2	18x95	3474
SS-1	STORM SLAT KIT-STORMSÄKRINGSLIST-STURMLEISTE SATZ-KIT DE LATTE ANTI TEMPÊTE 	8	18x40	2612
C8x80	COACH SCREW KIT 8x80-BULT-COACH SCHRAUBE SET-TIREFOND 	6	8x80	
	DOUBLE DOOR KIT ISO-DUBBELDÖRR BESLAG-TÜR SATZ-KIT DOUBLE PORTE 	1		
N 1.8x40	NAIL 1.8x40-SPIK-NAGEL-CLOU 	180	1.8x40	
	RAFTER DOWEL-TAKBJÄLKES TAPP-DACHSPARREN DÜBEL-CHEVILLE DE CHEVRON 	6		
Code	Cornelia40 ISO	Material	File	Cornelia40.dwg
			Page	ROOF

Pos	Specification-Spezifikation-Specificatie Cornelia40 ISO	St.	Profile (mm)	Length (mm)
RP2	ROOF PANEL 2-TAKPANEL-DACH ELEMENTE-DAKPANELEN-PANNEAU DE TOIT 	2	600x1445	
RP1	ROOF PANEL-TAKPANEL-DACH ELEMENTE-DAKPANELEN-PANNEAU DE TOIT 	4+4	1445x1347	
S4x60	SCREW 4x60-SKRUV-SCHRAUBE-VIS 	150	4x60	
S6x120	SCREW 6x120-SKRUV-SCHRAUBE-VIS 	40	6x120	
	WINDOW HANDLE FITTINGS-FÖNSTERHANDTAG-FENSTERBESCHLAG-FERRURE DE FENÊTRE  	4		
	WINDOW 1270x1325 DW0T 1270x1325-40 ISO 	2		
	DOOR 2600x1900 4DD08 F 2600x1900-40 ISO 	1		
Code	Cornelia40 ISO	Material	File	Cornelia40.dwg
			Page	ROOF

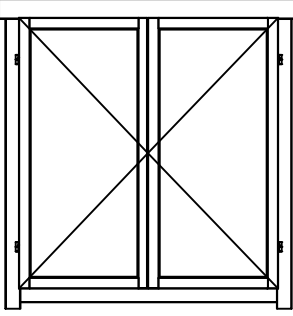
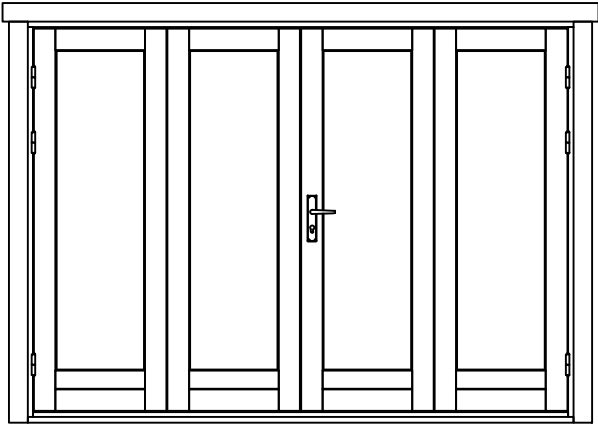
H = 1.500 m
TOTAL: 6.90 m²

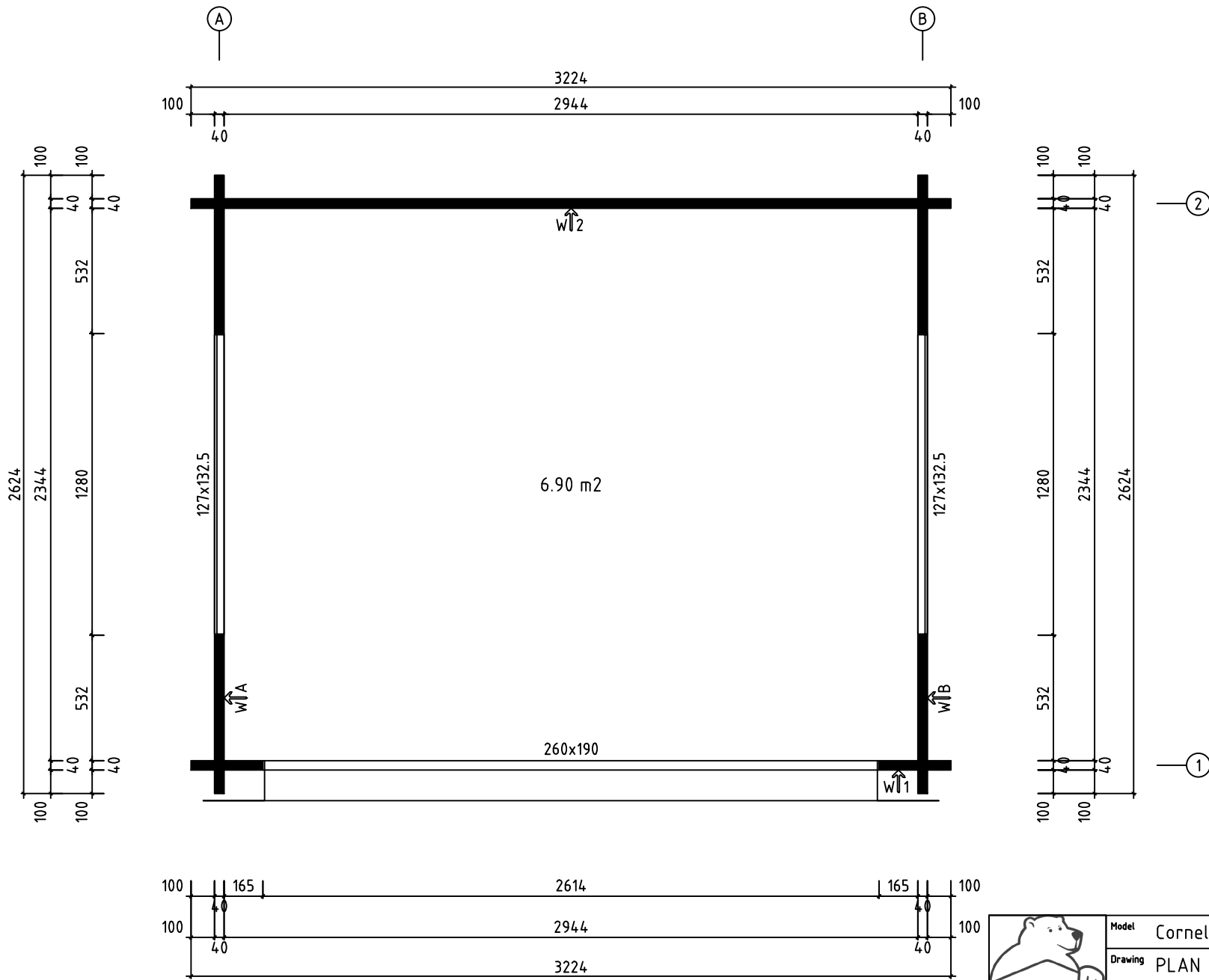

Model	Cornelia40	Page
Drawing	PLAN	Scale 1:20
Material	4x11.4	Date 19.05.2022
File	Cornelia40.dwg	Drawn by

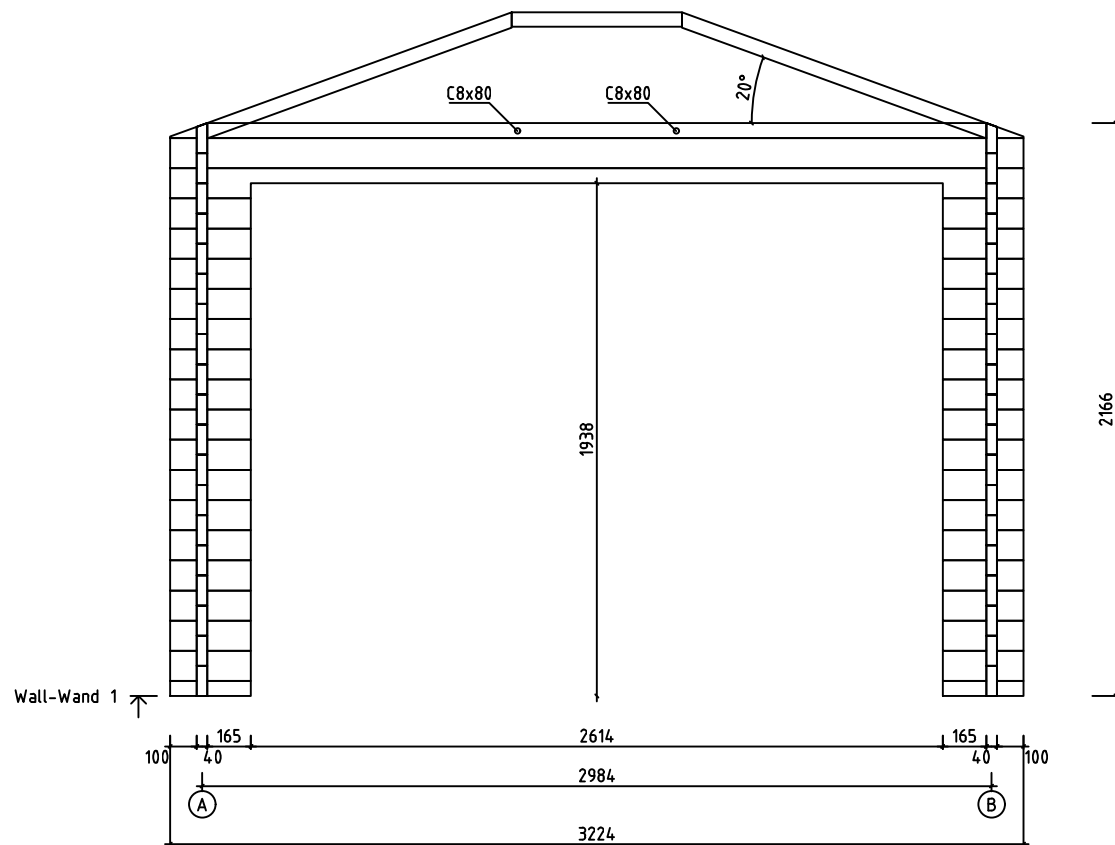
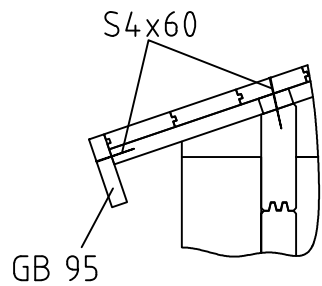

 Polhus <i>Quality wooden houses</i>	Model	Cornelia40	Page	6
	Drawing	WALL-WAND 1	Scale	1:20
	Material	4x11.4	Date	19.05.2022
	File	Cornelia40.dwg	Drawn by	

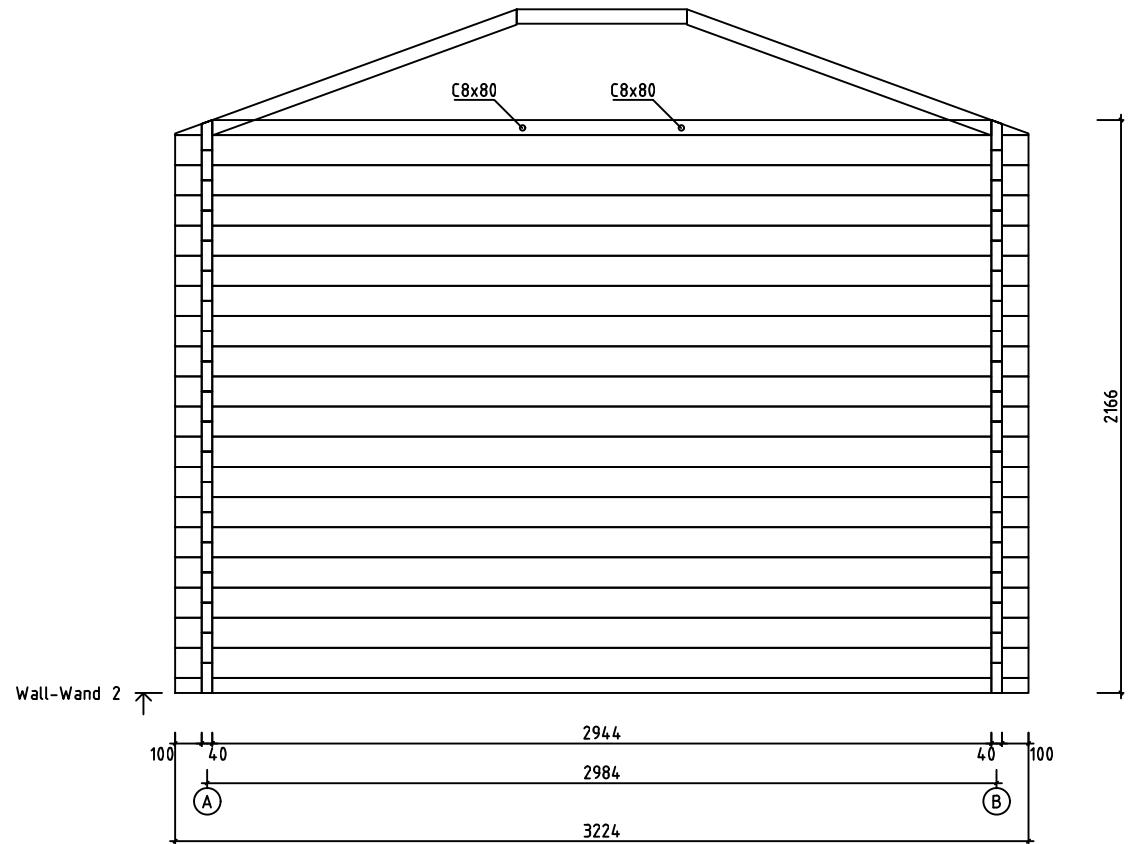

	Model	Cornelia40	Page	7
	Drawing	WALL-WAND 2	Scale	1:20
	Material	4x11.4	Date	19.05.2022
	File	Cornelia40.dwg	Drawn by	

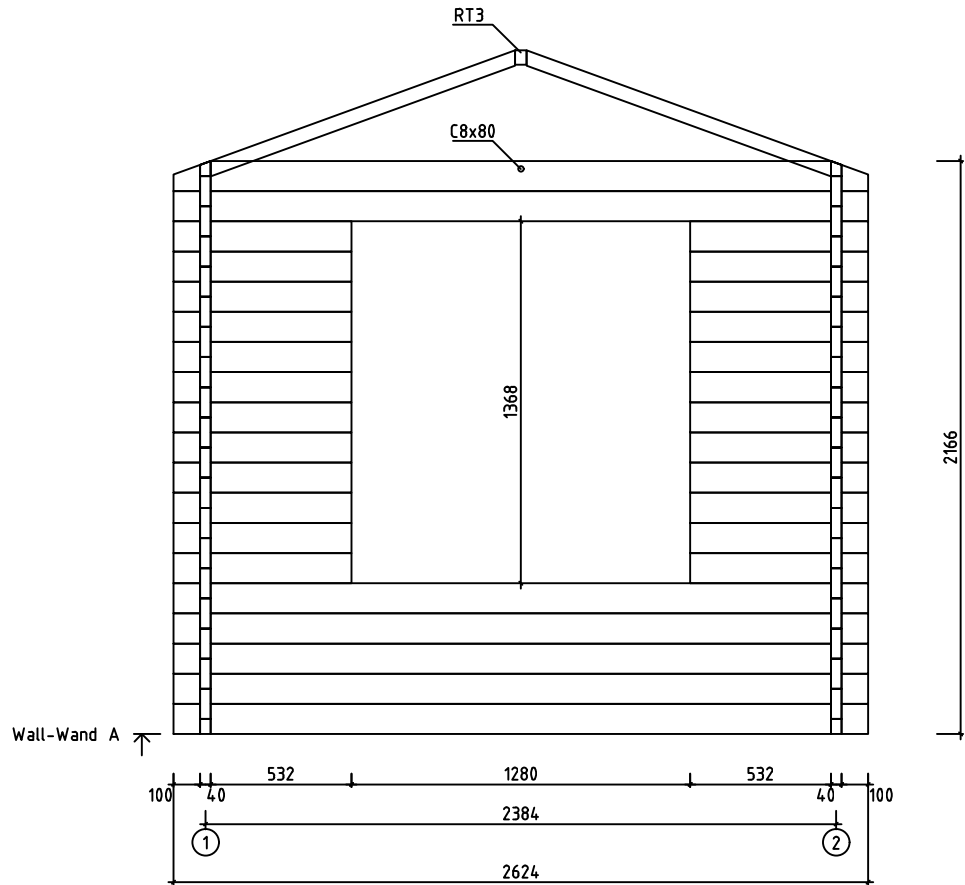

	Model	Cornelia40	Page	4
	Drawing	WALL-WAND A	Scale	1:20
	Material	4x11.4	Date	19.05.2022
	File	Cornelia40.dwg	Drawn by	

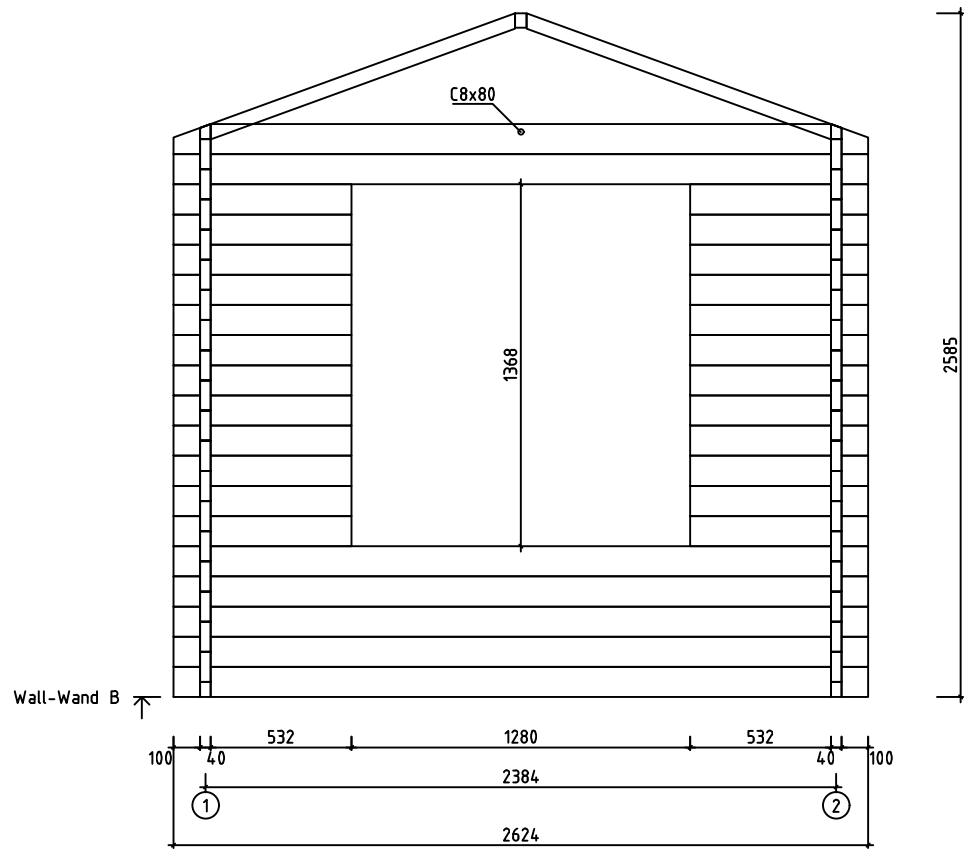

	Model	Cornelia40	Page	5
	Drawing	WALL-WAND B	Scale	1:20
	Material	4x11.4	Date	19.05.2022
	File	Cornelia40.dwg	Drawn by	

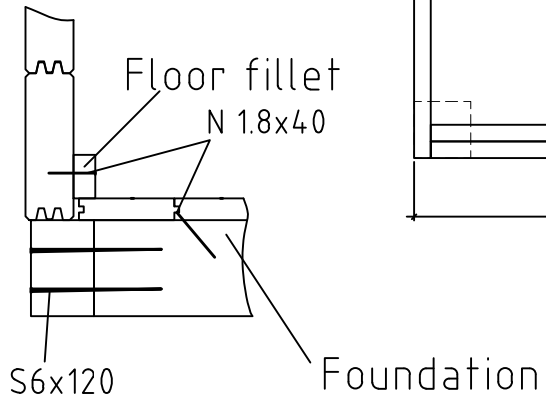
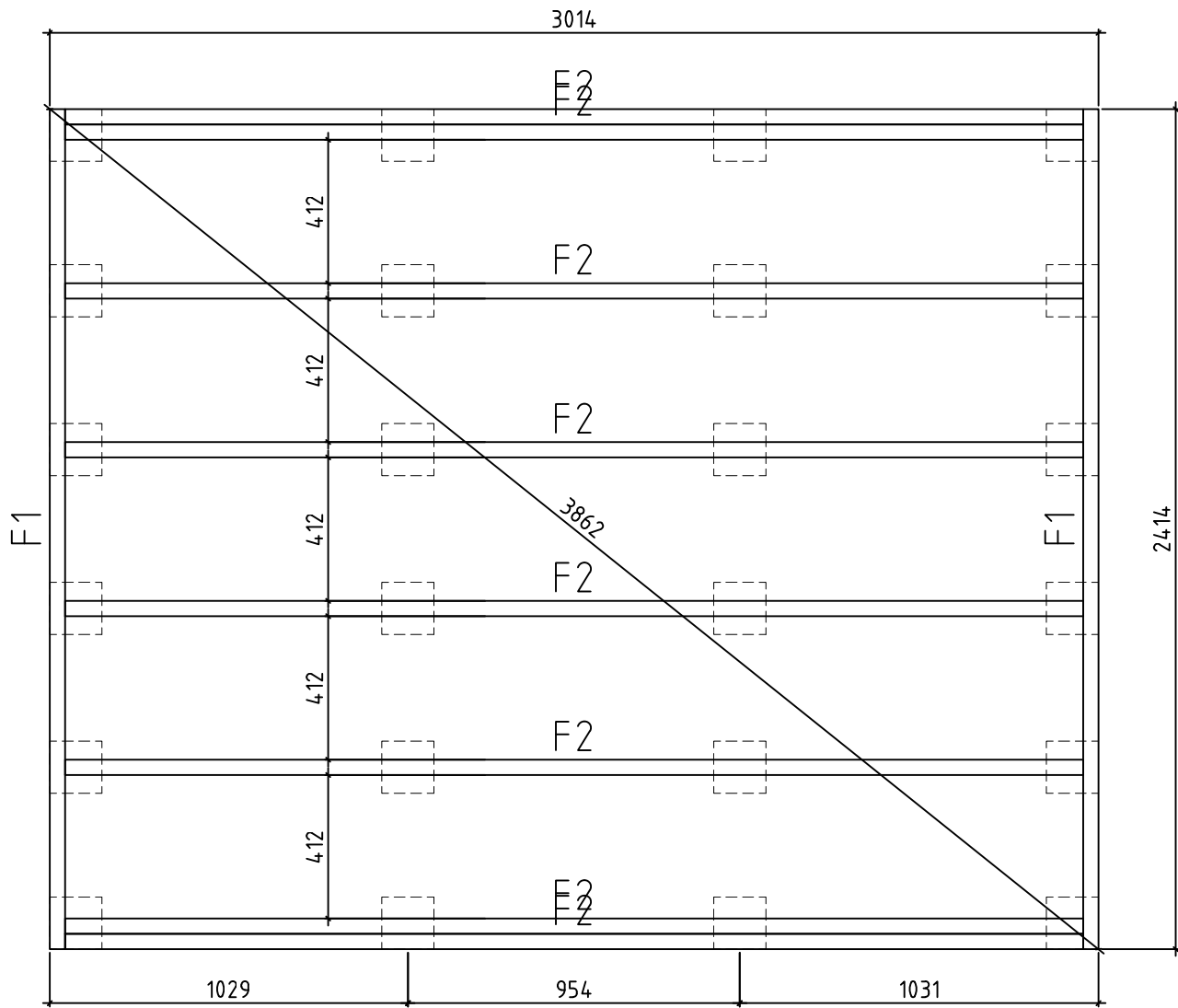

Model	Cornelia40	Page
Drawing	FOUNDATION	Scale 1:20
Material	4x11.4	Date 19.05.2022
File	Cornelia40.dwg	Drawn by

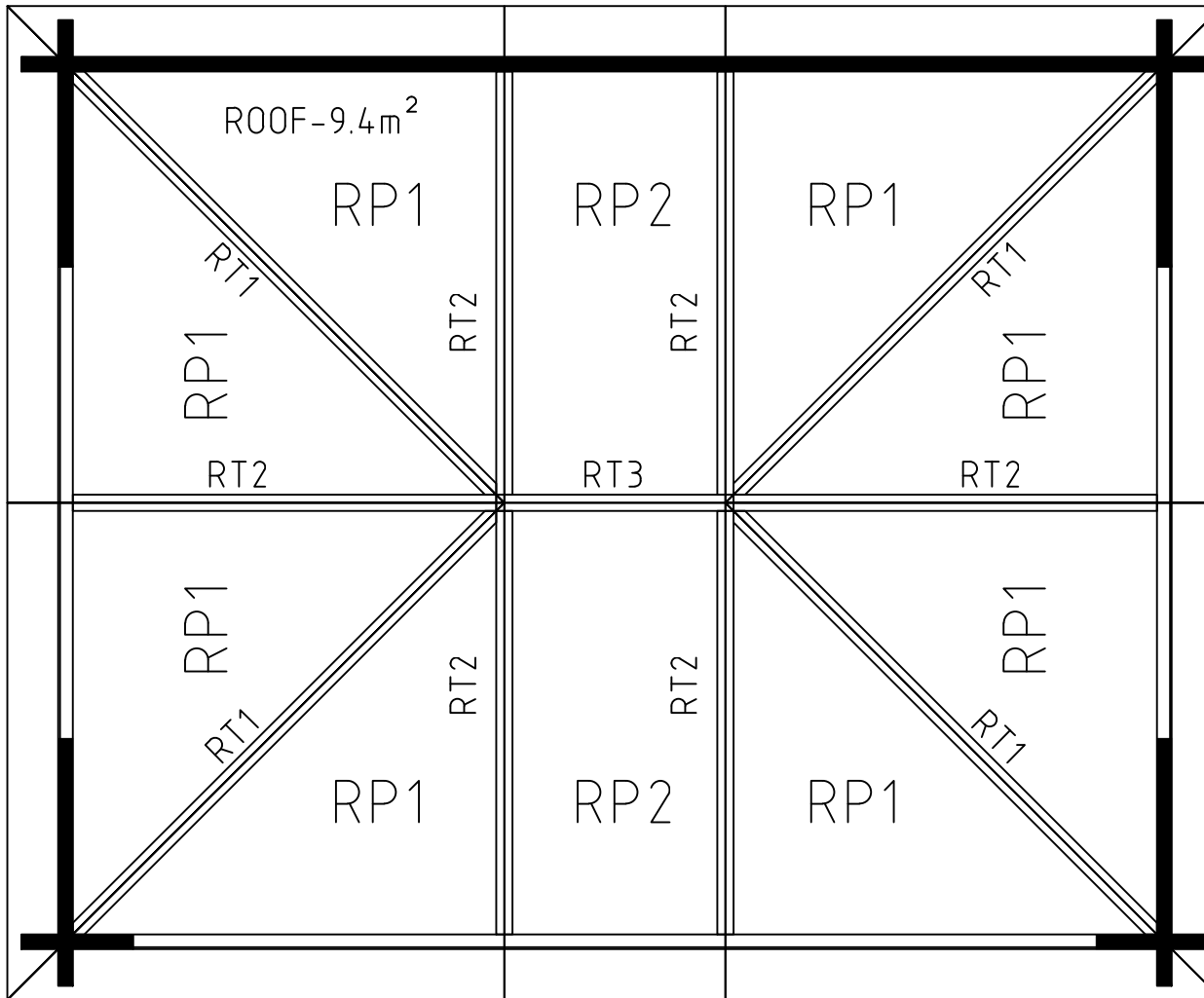

Model	Cornelia40	Page
Drawing	ROOF	Scale 1:20
Material	4x11.4	Date 19.05.2022
File	Cornelia40.dwg	Drawn by

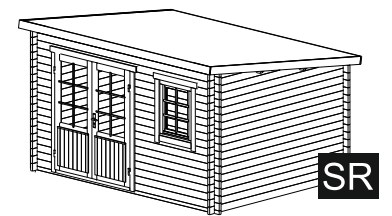
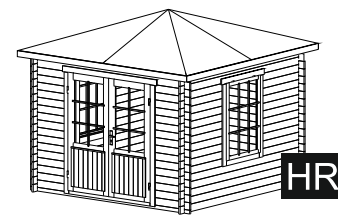
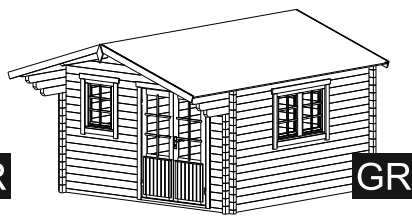
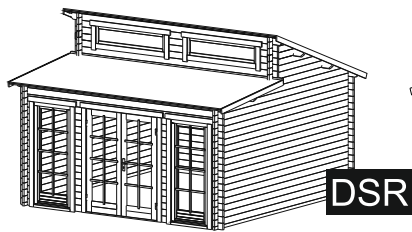
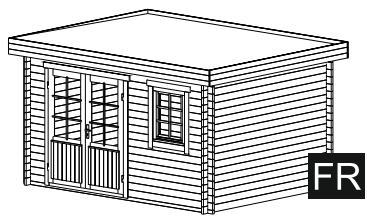

FR

DSR

GR

HR

SR

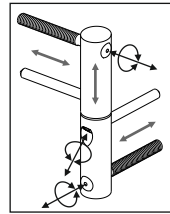
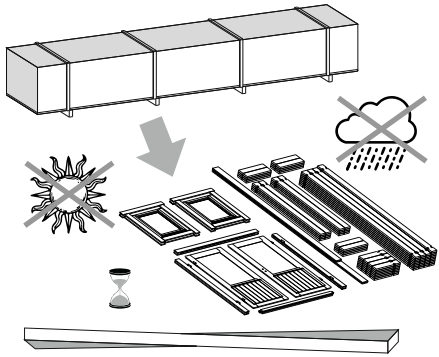

ADJUSTABLE HINGES

3.

TYPE- A
5x90

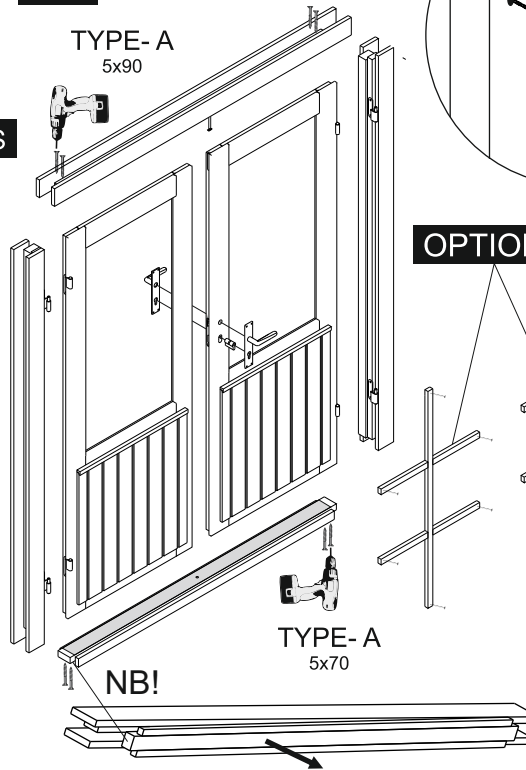

OPTIONS

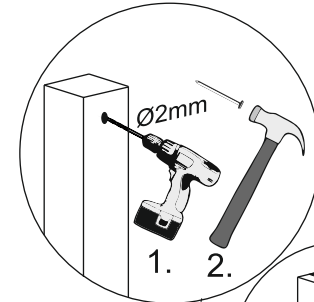

1. 2.

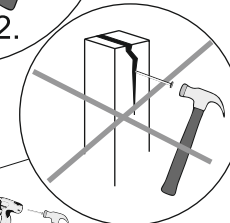

4.

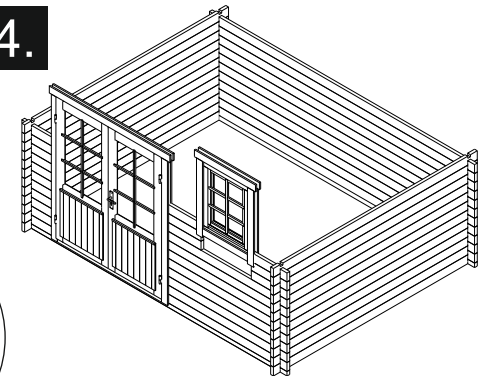

1.

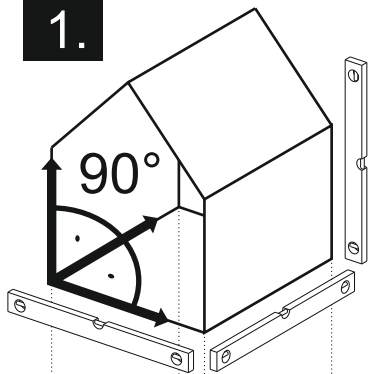

90°

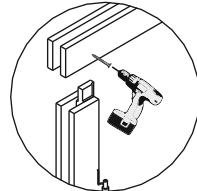

TYPE- B
4x60

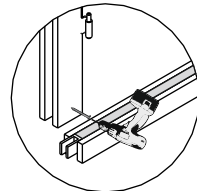

TYPE- A
5x70

NB!

5.

OPTIONS

Ø4mm

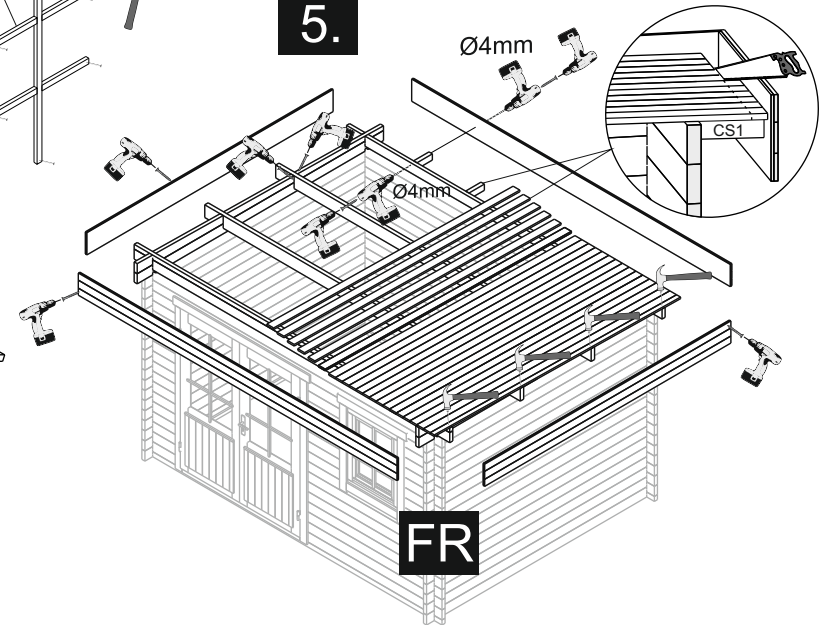

FR

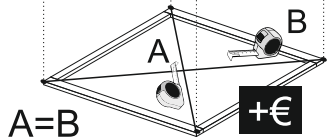

A

B

A=B

+€

2.

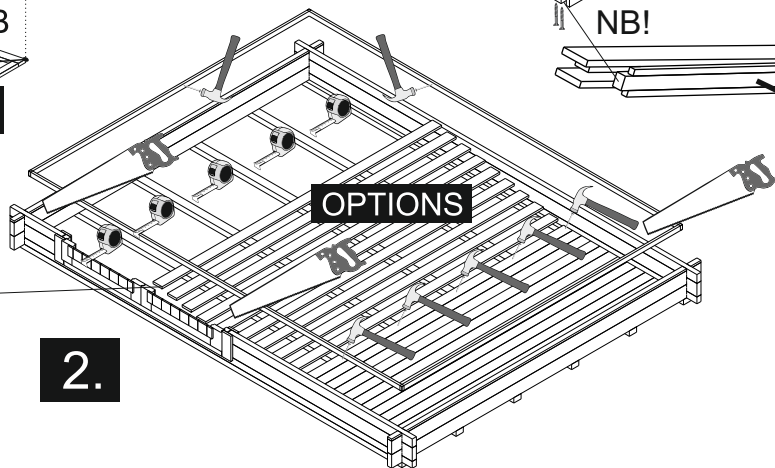

OPTIONS

The guide is illustrative. This guide is not project specification.
Der Leitfaden ist illustrativ. Dieser Leitfaden ist keine Projektspezifikation.
De gids is illustratief. Deze gids is geen projectspecificatie.

5.

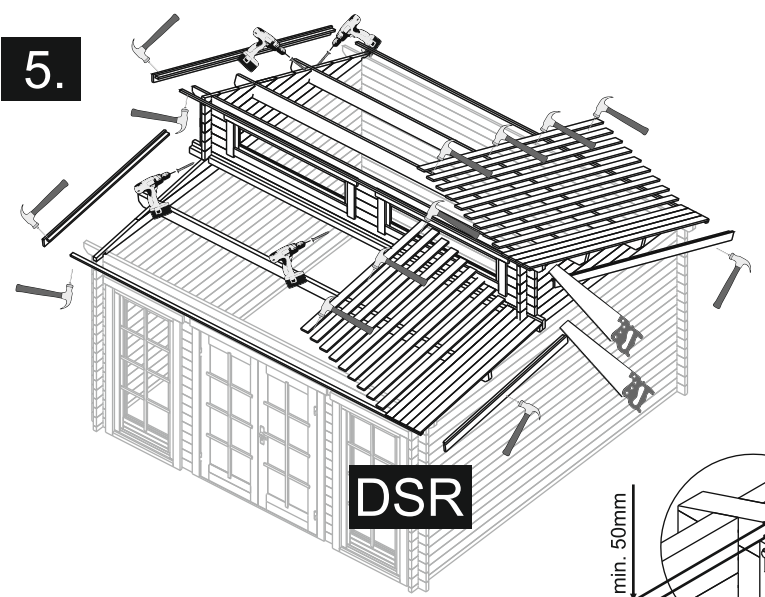

5.

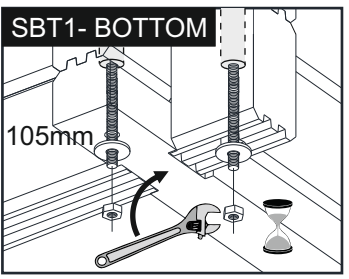
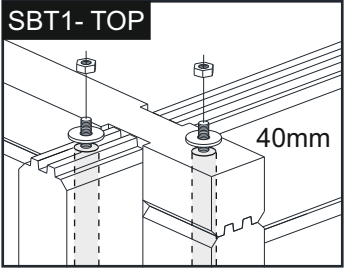
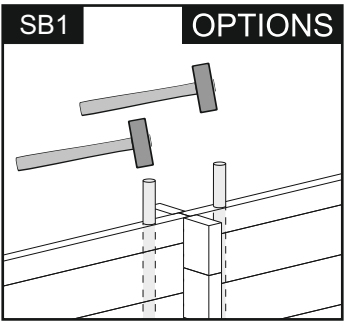
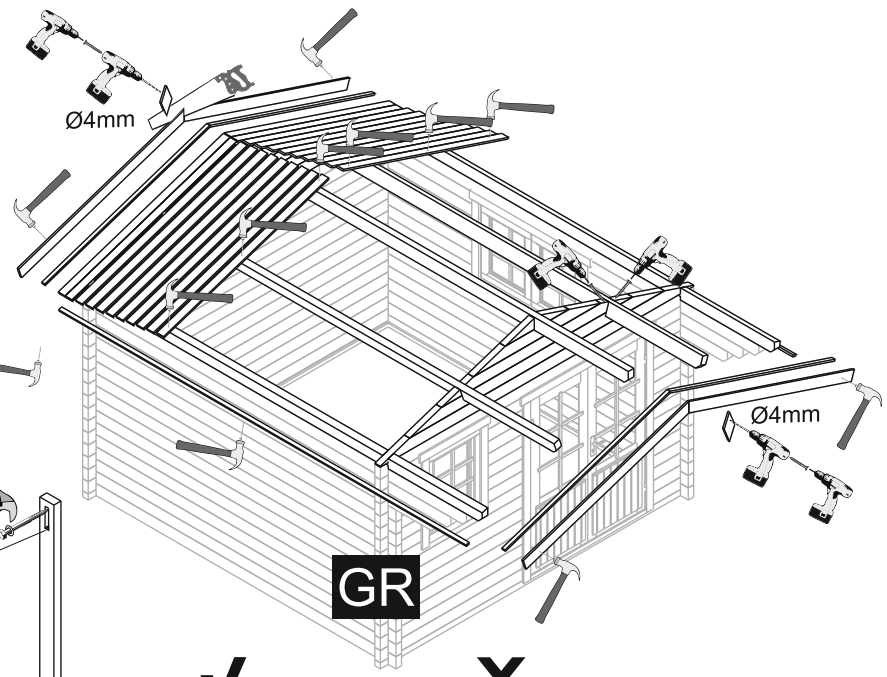

NB!

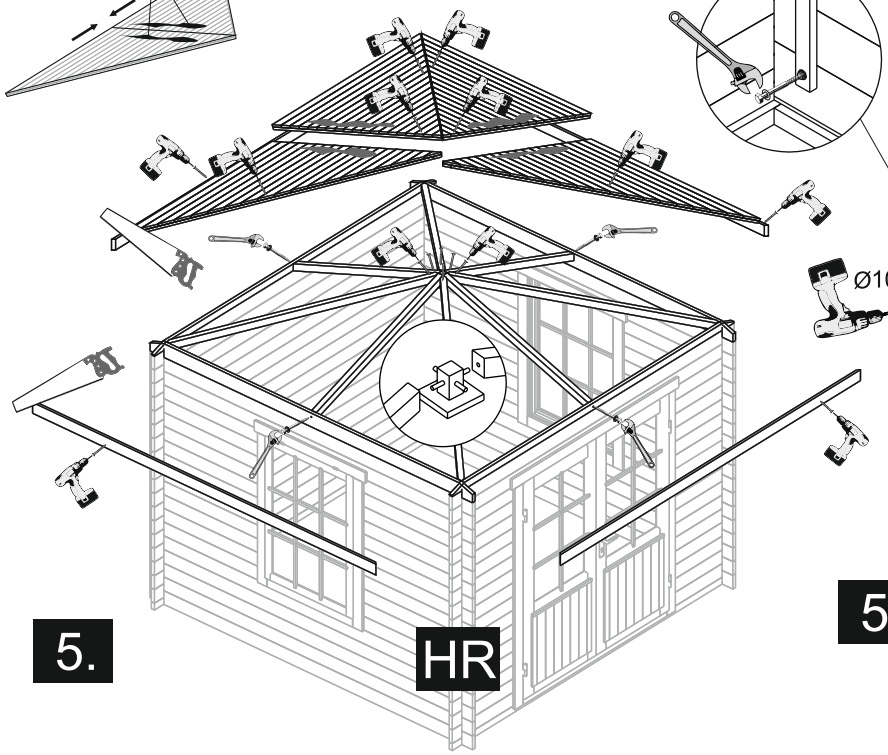

5.

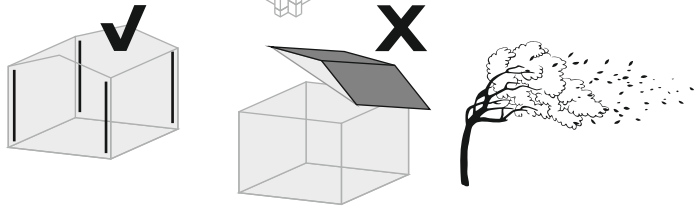

OPTIONS- STORM BRACES

Ø10mm

5.

